

# SERIE SERIES 64



**SERRATURE SERRABLINDA**  
**SERRABLINDA LOCKS**



**MADE  
IN  
ITALY**

## 64.562

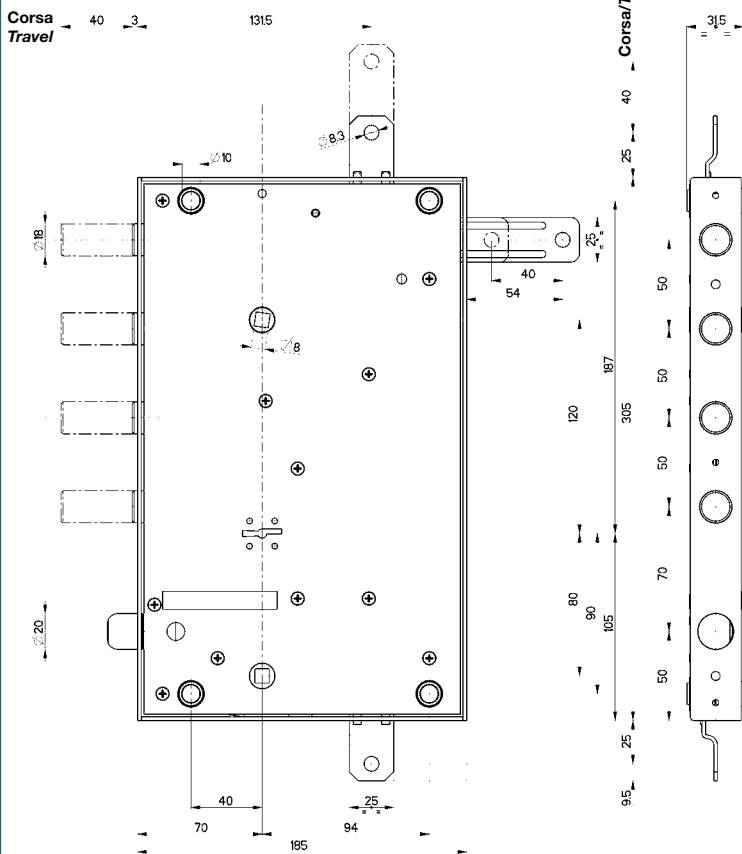

MADE IN ITALY

**A richiesta** le serrature possono essere fornite con:

- chiavi gambo mm. 50 art. 92270
- chiavi gambo mm. 60 art. 92106
- chiavi gambo mm. 85 art. 92188
- boccole guida chiave sia interne che esterne art. 99101V o 99101N

**On request**, locks can be supplied with:

- 50 mm. stem keys, Art. 92270
- 60 mm. stem keys, Art. 92106
- 85 mm. stem keys, Art. 92188
- internal and external key guide bushings, Art. 99101V or 99101N

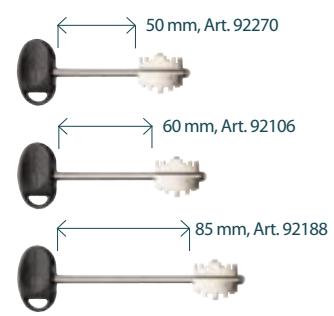

3 chiavi mm. 40 art. 92187  
 three keys 40 mm., Art. 92187

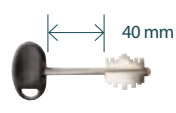

## 64.560



**Laterale** con mezzo giro Ø 20 azionato da chiave e quadro maniglia  $\square$  8  
 Entrata chiave e maniglia mm. 70  
 N. 4 chiavistelli tondi Ø 18  
 Corsa chiavistelli mm. 40  
 La serratura è corredata da:

- n. 3 chiavi doppia mappa mm. 40 art. 92187
- n. 1 mostrina interna art. 95314
- n. 1 mostrina esterna art. 95315

L'articolo viene fornito destro o sinistro (specificare nell'ordine)  
**Mezzo giro Reversibile**  
 Gli altri accessori **NON** sono compresi

**Side lock** with Ø 20 latchbolt operated by key and 8 handle square  
 Key and handle backset: 70 mm.  
 4 round Ø 18 bolts  
 Bolt travel: 40 mm.  
 Supplied with:

- 3 double-bitted keys 40 mm, Art. 92187
- 1 internal escutcheon, Art. 95314
- 1 external escutcheon, Art. 95315

The article is available in right or left version (please specify with order)  
**Reversible latchbolt**  
 Other accessories **NOT** included

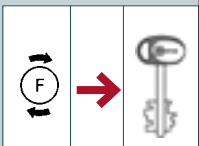

## 64.561



**Triplice** con mezzo giro Ø 20 azionato da chiave e quadro maniglia  $\square$  8  
 Entrata chiave e maniglia mm. 70  
 N. 4 chiavistelli tondi Ø 18  
 Corsa chiavistelli mm. 40  
 Corsa aste mm. 40  
 La serratura è corredata da:

- n. 3 chiavi doppia mappa mm. 40 art. 92187
- n. 1 mostrina interna art. 95314
- n. 1 mostrina esterna art. 95315

L'articolo viene fornito destro o sinistro (specificare nell'ordine)  
**Mezzo giro Reversibile**  
 Gli altri accessori **NON** sono compresi

**Three-point** lock with Ø 20 latchbolt operated by key and 8 handle square  
 Key and handle backset: 70 mm.  
 4 round Ø 18 bolts  
 Bolt travel: 40 mm.  
 Bar travel: 40 mm.  
 Supplied with:

- 3 double-bitted keys 40 mm., Art. 92187
- 1 internal escutcheon, Art. 95314
- 1 external escutcheon, Art. 95315

The article is available in right or left version (please specify with order)  
**Reversible latchbolt**  
 Other accessories **NOT** included

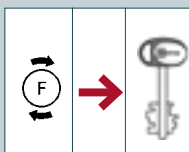

## 64.562

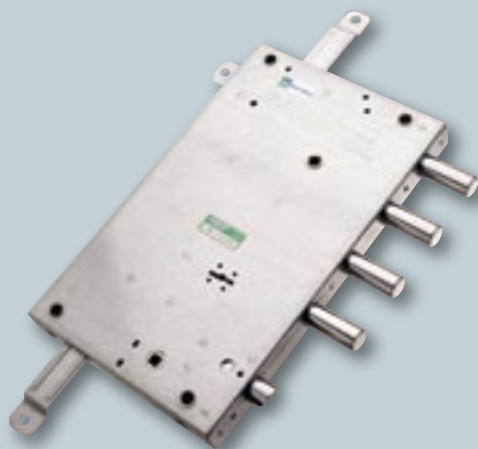

**Quintuplice** con mezzo giro Ø 20 azionato da chiave e quadro maniglia  $\square$  8  
 Entrata chiave e maniglia mm. 70  
 N. 4 chiavistelli tondi Ø 18  
 Corsa chiavistelli mm. 40  
 Corsa aste mm. 40  
 La serratura è corredata da:

- n. 3 chiavi doppia mappa mm. 40 art. 92187
- n. 1 mostrina interna art. 95314
- n. 1 mostrina esterna art. 95315

L'articolo viene fornito destro o sinistro (specificare nell'ordine)  
**Mezzo giro Reversibile**  
 Gli altri accessori **NON** sono compresi

**Five-point** lock with Ø 20 latchbolt operated by key and 8 handle square  
 Key and handle backset: 70 mm.  
 4 round Ø 18 latchbolts  
 Bolt travel: 40 mm.  
 Bar travel: 40 mm.  
 Supplied with:

- 3 double-bitted keys 40 mm., Art. 92187
- 1 internal escutcheon, Art. 95314
- 1 external escutcheon, Art. 95315

The article is available in right or left version (please specify with order)  
**Reversible latchbolt**  
 Other accessories **NOT** included

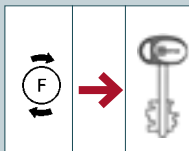

## 64.565

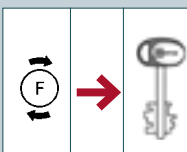
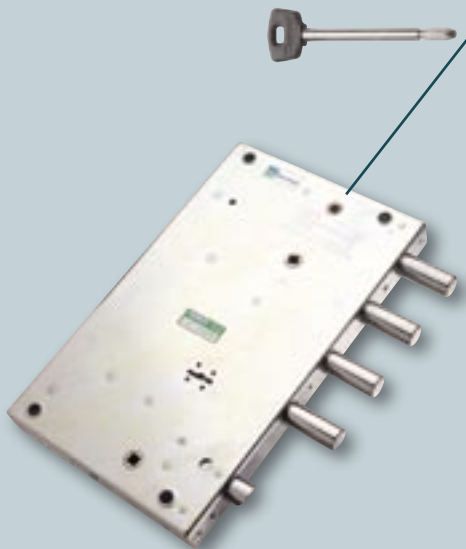

**Laterale** con mezzo giro Ø 20 azionato da chiave e quadro maniglia  $\square$  8  
 Entrata chiave e maniglia mm. 70

N. 4 chiavistelli tondi Ø 18

Corsa chiavistelli mm. 40

La serratura è corredata da:

- n. 3 chiavi doppia mappa mm. 40 art. 92187
- n. 3 chiavi art. 92103 comando chiavistelli
- n. 1 mostrina interna art. 95314
- n. 1 mostrina esterna art. 95315
- n. 2 mostrine (per chiave a spillo) art. 95321

L'articolo viene fornito destro o sinistro (specificare nell'ordine)

**Mezzo giro Reversibile**

Gli altri accessori **NON** sono compresi

**Side lock with Ø 20 latchbolt operated by key and 8 handle square**

Key and handle backset: 70 mm.

4 round Ø 18 bolts

Bolt travel: 40 mm.

Supplied with:

- 3 double-bitted keys 40 mm., Art. 92187
- 3 keys, Art. 92103 for bolt control
- 1 internal escutcheon, Art. 95314
- 1 external escutcheon, Art. 95315
- set of 2 escutcheons (for pointed key), Art. 95321

The article is available in right or left version (please specify with order)

**Lock with reversible latchbolt**

Other accessories **NOT** included

## 64.566

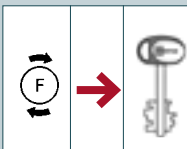
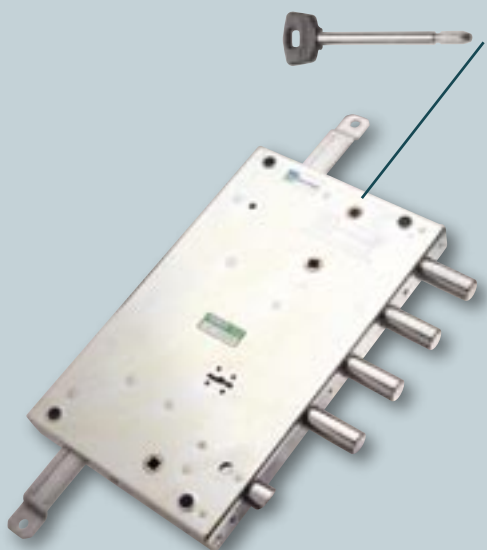

**Triplice** con mezzo giro Ø 20 azionato da chiave e quadro maniglia  $\square$  8

Entrata chiave e maniglia mm. 70

N. 4 chiavistelli tondi Ø 18

Corsa chiavistelli e aste mm. 40

La serratura è corredata da:

- n. 3 chiavi doppia mappa mm. 40 art. 92187
- n. 3 chiavi art. 92103 comando chiavistelli
- n. 1 mostrina interna art. 95314
- n. 1 mostrina esterna art. 95315
- n. 2 mostrine (per chiave a spillo) art. 95321

L'articolo viene fornito destro o sinistro (specificare nell'ordine)

**Mezzo giro Reversibile**

Gli altri accessori **NON** sono compresi

**Three-point lock with Ø 20 latchbolt operated by key and 8 handle square**

Key and handle backset: 70 mm.

4 round Ø 18 bolts

Bolt and bar travel: 40 mm.

Supplied with:

- 3 double-bitted keys 40 mm., Art. 92187
- 3 keys, Art. 92103 for bolt control
- 1 internal escutcheon, Art. 95314
- 1 external escutcheon, Art. 95315
- set of 2 escutcheons (for pointed key), Art. 95321

The article is available in right or left version (please specify with order)

**Lock with reversible latchbolt**

Other accessories **NOT** included

## 64.568



**Triplice** con mezzo giro Ø 20 azionato dal pomolo che comanda i chiavistelli  
 Entrata chiave e pomolo mm. 70  
 N. 4 chiavistelli tondi Ø 18  
 Corsa chiavistelli e aste mm. 40  
 La serratura è corredata da:

- n. 3 chiavi doppia mappa mm. 40 art. 92187
- n. 1 mostrina interna art. 95314
- n. 1 mostrina esterna art. 95315

L'articolo viene fornito destro o sinistro (specificare nell'ordine)  
**Mezzo giro Reversibile**  
 Gli altri accessori **NON** sono compresi

**Three-point** lock with Ø 20 latchbolt operated by knob controlling bolts  
 Key and knob backset: 70 mm.  
 4 round Ø 18 bolts  
 Bolt and bar travel: 40 mm.  
 Supplied with:

- 3 double-bitted keys 40 mm., Art. 92187
- 1 internal escutcheon, Art. 95314
- 1 external escutcheon, Art. 95315

The article is available in right or left version (please specify with order)  
**Lock with reversible latchbolt**  
 Other accessories **NOT** included

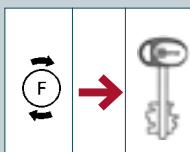

## 64.569



**Quintuplice** con mezzo giro Ø 20 azionato dal pomolo che comanda i chiavistelli  
 Entrata chiave e pomolo mm. 70  
 N. 4 chiavistelli tondi Ø 18  
 Corsa chiavistelli e aste mm. 40  
 La serratura è corredata da:

- n. 3 chiavi doppia mappa mm. 40 art. 92187
- n. 1 mostrina interna art. 95314
- n. 1 mostrina esterna art. 95315

L'articolo viene fornito destro o sinistro (specificare nell'ordine)  
**Mezzo giro Reversibile**  
 Gli altri accessori **NON** sono compresi

**Five-point** lock with Ø 20 latchbolt operated by knob controlling bolts  
 Key and knob backset: 70 mm  
 4 round Ø 18 bolts  
 Bolt and bar travel: 40 mm  
 Supplied with:

- 3 double-bitted keys 40 mm, Art. 92187
- 1 internal escutcheon, Art. 95314
- 1 external escutcheon, Art. 95315

The article is available in right or left version (please specify with order)  
**Lock with reversible latchbolt**  
 Other accessories **NOT** included

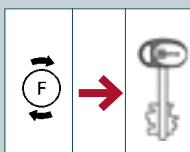

## 64.567

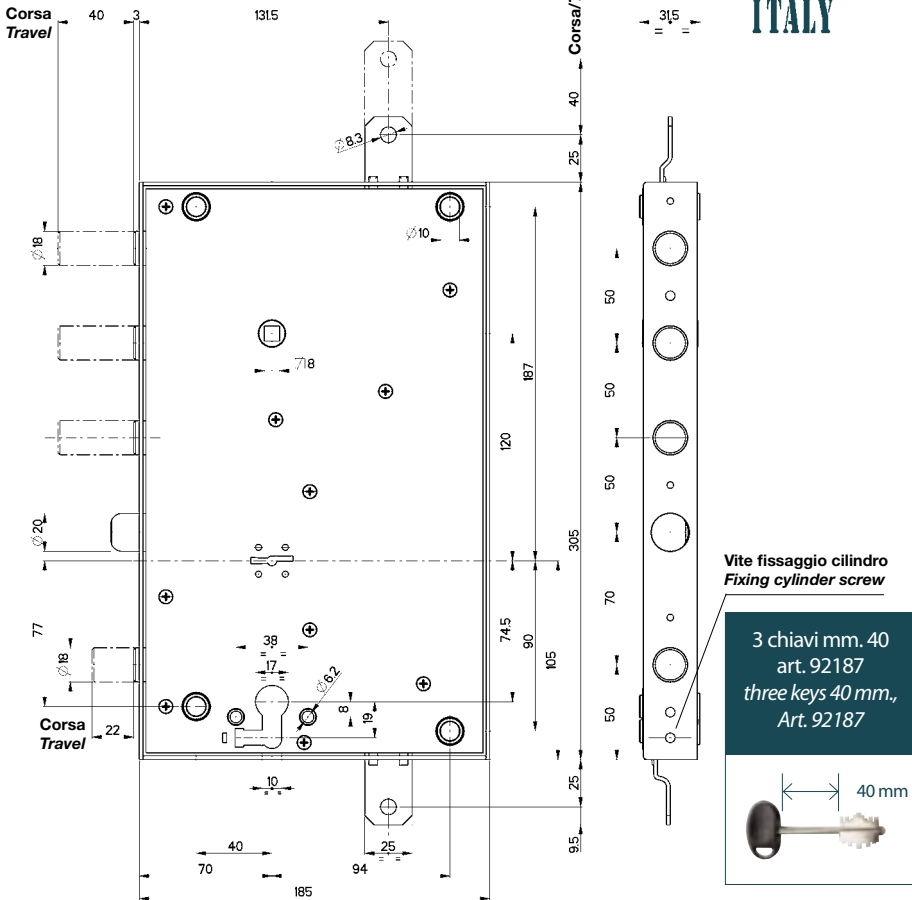

**A richiesta** le serrature possono essere fornite con:

- chiavi gambo mm. 50 art. 92270
- chiavi gambo mm. 60 art. 92106
- chiavi gambo mm. 85 art. 92188
- boccole guida chiave sia interne che esterne art. 99101V o 99101N

**On request**, locks can be supplied with:

- 50 mm. stem keys, Art. 92270
- 60 mm. stem keys, Art. 92106
- 85 mm. stem keys, Art. 92188
- internal and external key guide bushings, Art. 99101V or 99101N

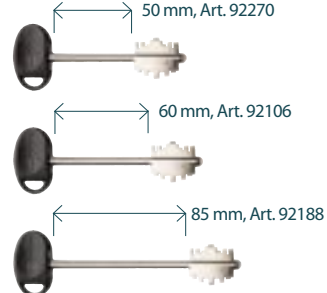

Abbinare Defender® TOP SYSTEM, LEVEL, BASIC (Ordinare a parte; vedere sezione 94)

For use with Defender® Ø 50 TOP SYSTEM, LEVEL, BASIC (Order separately; see section 94)

## 64.567



**SERRATURE INDEPENDENTI**

**INDEPENDENT LOCK**

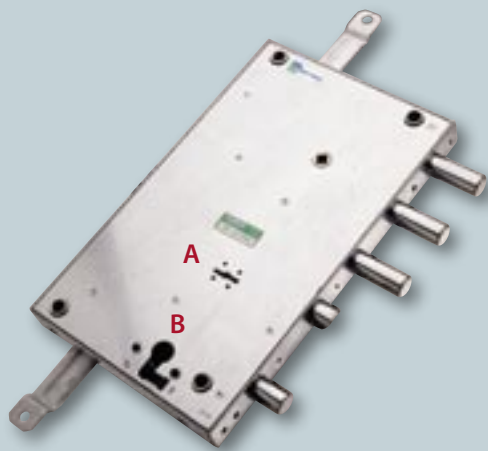

### Serratura superiore tripla a doppia mappa 4 mandate con comando chiavistelli e mezzo giro a pomolo

Entrata chiave, pomolo e cilindro servizio mm. 70  
N. 3 chiavistelli tondi Ø 18  
Corsa chiavistelli e aste mm. 40  
Corsa chiavistello azionato dal cilindro mm. 22  
Serratura inferiore 2 mandate a cilindro europeo con chiavistello tondo Ø 18  
La serratura è corredata da:

- n. 3 chiavi doppia mappa mm. 40 art. 92187
- n. 1 mostrina interna art. 95314
- n. 1 mostrina esterna art. 95315

L'articolo viene fornito destro o sinistro (specificare nell'ordine)  
Gli altri accessori **NON** sono compresi

### Three-point double-bitted upper lock, 4 turns with bolt and latchbolt control with knob Key, knob and service cylinder

Key and knob backset: 70 mm  
3 round Ø 18 bolts  
Bolt and bar travel: 40 mm  
Bolt travel operated by 22 mm cylinder  
Lower lock with Europrofile cylinder, 2 turns, with round Ø 18 latchbolt  
Supplied with:

- 3 double-bitted keys 40 mm, Art. 92187
- 1 internal escutcheon, Art. 95314
- 1 external escutcheon, Art. 95315

The article is available in right or left version (please specify with order)  
Other accessories **NOT** included

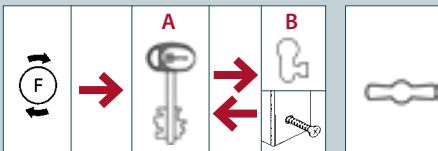

## 64.597



SERRATURE DIPENDENTI,  
 CON CHIUSURA ENTRATA  
 CHIAVE SUPERIORE  
 (SERRATURA INFERIORE  
 INDIPENDENTE)

DEPENDENT LOCKS  
 WITH LOCKING  
 OF UPPER KEYHOLE

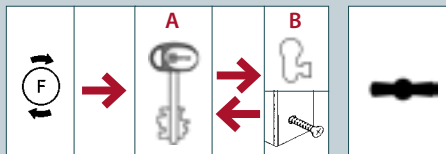
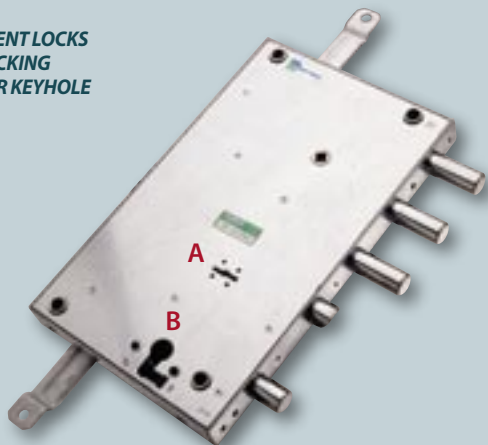

**Serratura superiore triplice a doppia mappa 4 mandate con comando chiavistelli e mezzo giro a pomolo**

Entrata chiave, pomolo e cilindro servizio mm. 70  
 N. 3 chiavistelli tondi Ø 18  
 Corsa chiavistelli e aste mm. 40  
 Corsa chiavistello azionato dal cilindro mm. 22  
 Serratura inferiore 2 mandate a cilindro europeo con chiavistello tondo Ø 18  
 Il cilindro aziona la chiusura entrata chiave della serratura superiore  
 La serratura è corredata da:

- n. 3 chiavi doppia mappa mm. 40 art. 92187
- n. 1 mostrina interna art. 95314
- n. 1 mostrina esterna art. 95315

L'articolo viene fornito destro o sinistro (specificare nell'ordine)  
 Gli altri accessori **NON** sono compresi

**Three-point double-bitted upper lock with 4 turns, with bolt and latchbolt control with knob. Key, knob and service cylinder.**

Key and knob backset: 70 mm.  
 3 round Ø 18 bolts  
 Bolt and bar travel: 40 mm.  
 Bolt travel operated by 22 mm. cylinder  
 Lower lock with Europrofile cylinder, 2 turns, with round Ø 18 bolt  
 The cylinder operates the locking of the upper keyhole  
 Supplied with:

- 3 double-bitted keys 40 mm., Art. 92187
- 1 internal escutcheon, Art. 95314
- 1 external escutcheon, Art. 95315

The article is available in right or left version (please specify with order)  
 Other accessories **NOT** included



SERRATURE SERRABLINDA AD INFILARE / MORTISE-TYPE SERRABLINDA LOCKS

### 64.761

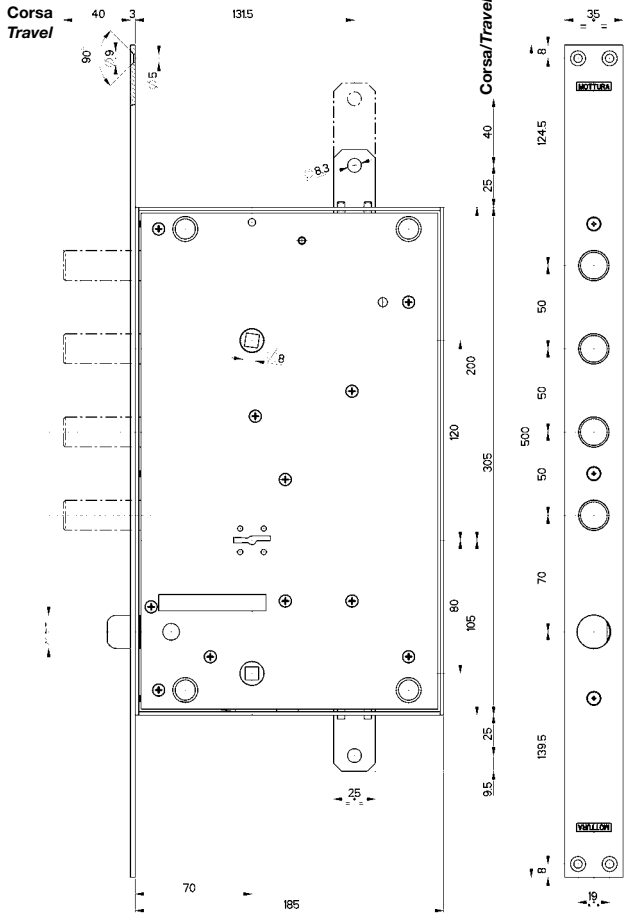

**MADE  
IN  
ITALY**

**A richiesta** le serrature possono essere fornite con:

- chiavi gambo mm. 50 art. 92270
- chiavi gambo mm. 60 art. 92106
- chiavi gambo mm. 85 art. 92188
- boccole guida chiave sia interne che esterne art. 99101V o 99101N

**On request**, locks can be supplied with:

- 50 mm. stem keys, Art. 92270
- 60 mm. stem keys, Art. 92106
- 85 mm. stem keys, Art. 92188
- internal and external key guide bushings, Art. 99101V or 99101N

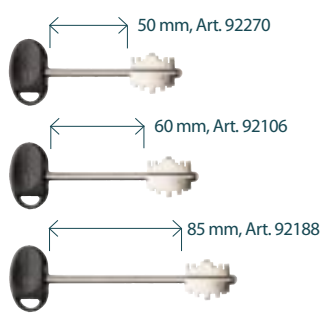

3 chiavi mm. 40  
art. 92187  
three keys 40 mm.,  
Art. 92187

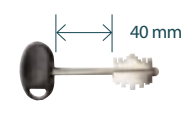

### 64.760

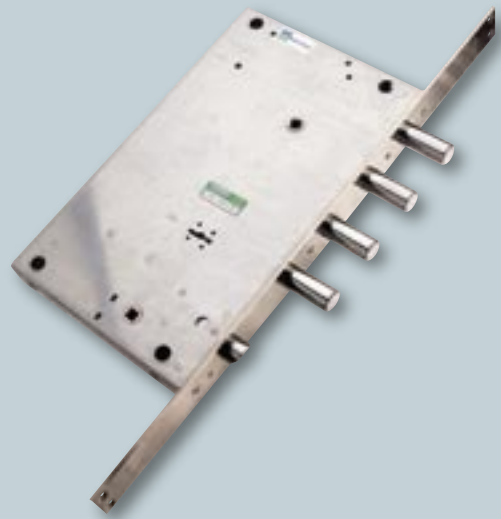

**Laterale** con mezzo giro Ø 20 azionato da chiave e quadro maniglia  $\square$  8  
Entrata chiave e maniglia mm. 70  
N. 4 chiavistelli tondi Ø 18 - Corsa chiavistelli mm. 40  
La serratura è corredata da:

- n. 3 chiavi doppia mappa mm. 40 art. 92187
- n. 1 mostrina interna art. 95314
- n. 1 mostrina esterna art. 95315

L'articolo viene fornito destro o sinistro (specificare nell'ordine)  
**Mezzo giro Reversibile**  
Gli altri accessori **NON** sono compresi

**Side lock** with Ø 20 latchbolt operated by key and 8 handle square  
Key and handle backset: 70 mm.  
4 round Ø 18 bolts  
Bolt travel: 40 mm.  
Supplied with:

- 3 double-bitted keys 40 mm., Art. 92187
- 1 internal escutcheon, Art. 95314
- 1 external escutcheon, Art. 95315

The article is available in right or left version (please specify with order)  
**Reversible latchbolt**  
Other accessories **NOT** included

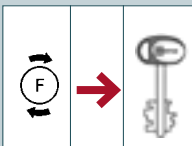



64.761

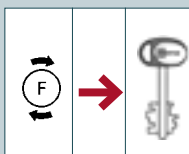
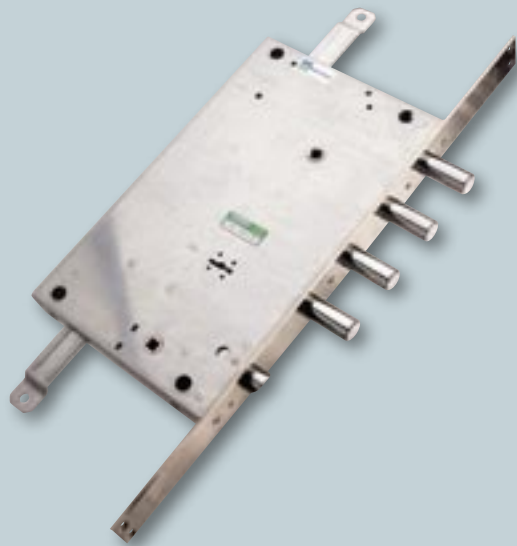

**Triplice** con mezzo giro Ø 20 azionato da chiave e quadro maniglia  $\square$  8  
Entrata chiave e maniglia mm. 70

N. 4 chiavistelli tondi Ø 18

Corsa chiavistelli e aste mm. 40

La serratura è corredata da:

- n. 3 chiavi doppia mappa mm. 40 art. 92187
- n. 1 mostrina interna art. 95314
- n. 1 mostrina esterna art. 95315

L'articolo viene fornito destro o sinistro (specificare nell'ordine)

**Mezzo giro Reversibile**

Gli altri accessori **NON** sono compresi

**Three-point** lock with Ø 20 latchbolt operated by key and 8 handle square  
Key and handle backset: 70 mm.

4 round Ø 18 bolts

Bolt travel: 40 mm.

Lock supplied with:

- 3 double-bitted keys 40 mm., Art. 92187
- 1 internal escutcheon, Art. 95314
- 1 external escutcheon, Art. 95315

The article is available in right or left version (please specify with order)

**Reversible latchbolt**

Other accessories **NOT** included

64.766

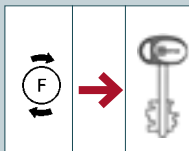
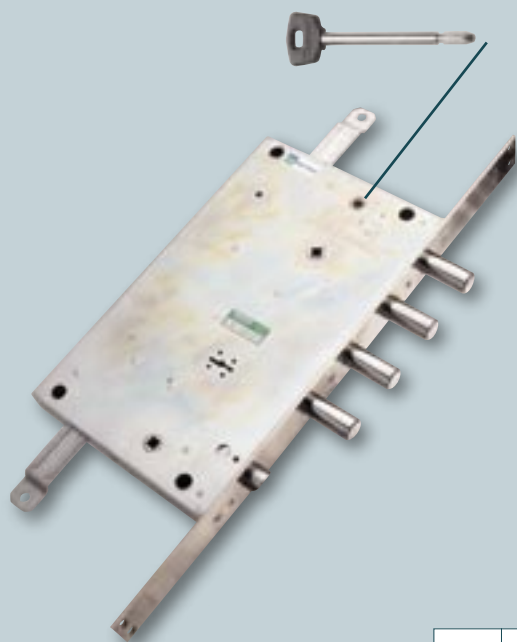

Versione comando chiavistelli mediante chiave a spillo  
e blocco con chiave doppia mappa

**Triplice** con mezzo giro Ø 20 azionato da chiave e quadro maniglia  $\square$  8

Entrata chiave e maniglia mm. 70

N. 4 chiavistelli tondi Ø 18

Corsa chiavistelli e aste mm. 40

La serratura è corredata da:

- n. 3 chiavi doppia mappa mm. 40 art. 92187
- n. 3 chiavi art. 92103 comando chiavistelli
- n. 1 mostrina interna art. 95314
- n. 1 mostrina esterna art. 95315
- n. 2 mostrine (per chiave a spillo) art. 95321

L'articolo viene fornito destro o sinistro (specificare nell'ordine)

**Mezzo giro Reversibile**

Gli altri accessori **NON** sono compresi

**Version with bolt control by means of pointed key  
and locking with double bitted key**

**Three-point** lock with Ø 20 latchbolt operated by key and 8 handle square  
Key and handle backset: 70 mm.

4 round Ø 18 bolts

Bolt and bar travel: 40 mm.

Supplied with:

- 3 double-bitted keys 40 mm., Art. 92187
- 3 keys, Art. 92103 for bolt control
- 1 internal escutcheon, Art. 95314
- 1 external escutcheon, Art. 95315
- set of 2 escutcheons for pointed key, Art. 95321

The article is available in right or left version (please specify with order)

**Reversible latchbolt**

Other accessories **NOT** included

