

Model series 118, 128 and 138 at a glance

Standard electric strike 118, minimum fitting size - maximum effect

effeff standard electric strike 118

With the minimal size of 66 mm x 25,5 mm the electric strike 118 from effeff is the world wide smallest standard strike.

The advantages at a glance:

- Radius keeper, FaFix 3 mm adjustable
- Universal voltage
- Pluggable connecting cable available
- Compatible with all current mortise locks
- Compatible with all commercially available striking plates also striking plates for plastic profiles
- Extended time test 250.000 cycles
- Symmetrical design. DIN left/right as well as horizontal applicable

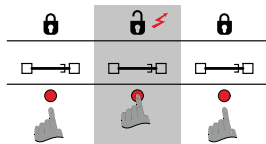

Fail locked function

The door can only be opened while a contact is made. In alternating current operation, a humming noise is audible. In direct current operation, there is no noise.

Adjustable keeper (FF, FaFix)	Monitoring contact (RR)	Mechanical unlocking (E)	Diode (05)	Sliding ramp	Fail-locked	Model
•					•	118
•		•			•	118E
•	•				•	118RR
•			•		•	11805
•	•		•		•	11805RR

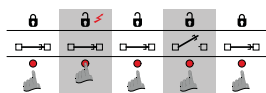

Hold-open function

The latch bolt-controlled hold-open catch in the centre of the keeper holds the strike unlocked even after a contact is made until the door is opened.

Adjustable keeper (FF, FaFix)	Mechanical unlocking (E)	Hold-open function	Model
•		•	128
•	•	•	128E

118 128 138

Model series 118, 128 and 138 at a glance

Standard electric strike 118, minimum fitting size - maximum effect

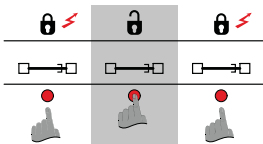

Fail-unlocked function

The strike is blocked as long as the power is switched on. Once the current is switched off or interrupted due to a power failure, the keeper can be moved and the door opened.

Adjustable keeper (FF, FaFix)	Monitoring contact (RR)	Diode (05)	Fail-unlocked	Model
•			•	138
•	•		•	138RR
•		•	•	13805
•	•	•	•	13805RR

Fail-locked 118/128

118 128 138

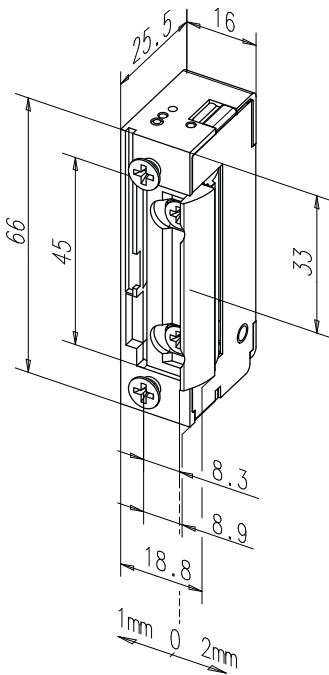

Minimum fitting size - maximum effect
effeff standard electric strike 118 with FaFix (FF)

Model with basic features.

The advantages at a glance

- Radius keeper, FaFix 3 mm adjustable
- Universal voltage
- Compatible with all current mortise locks
- Compatible with all commercially available striking plates also striking plates for plastic profiles
- Symmetrical design. DIN left/right as well as horizontal applicable

Electrical data	10-24 V AC/DC	22-42 V AC/DC
Rated resistance	43 Ω	200 Ω
AC current consumption	250 mA (12V) 500 mA (24V)	60 mA
Current consumption DC (stabilised)	280 mA (12V) 560 mA (24V)	120 mA
Max. keeper pre-load AC	200 N (12V) 250 N (24V)	200 N
Max. keeper pre-load DC (stabilised)	50 N (12V) 200 N (24V)	50 N

Characteristics	Technical attributes
Adjustable keeper (FF, FaFix)	• Break-in resistance 3750 N
Adjustable strike (F, Fix)	Height 66 mm
Monitoring contact (RR)	Width 16 mm
Mechanical unlocking (E)	Depth 25,5 mm
Diode (05)	Operating temperature range -15 °C to +40 °C
Fail-locked	• Installation position vertical and horizontal
Hold-open function	Material housing Die-cast zinc
	Material keeper Die-cast zinc
	Fafix regulating range 3 mm
	Latch bolt engaging depth 5,5 mm
	Internal works continuous function load cycles 250000

DIN directions	
Universal	1
Voltage	
10-24 V AC/DC	A7
22-42 V AC/DC	B7

Order no.
118----- ** *

Order suffix for model with hold open function = 128 -...

Standard combinations fail-locked 118/128

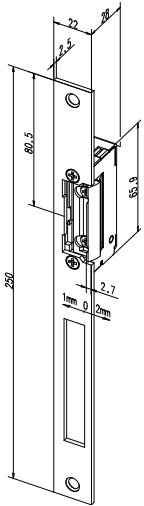

Electric strike 118 with flat striking plate 434

With 2 fixing holes, for steel doors

Technical attributes	
Colour	35
Type	HZ

DIN directions	
Universal	1

Voltage	
10-24 V AC/DC	A7
22-42 V AC/DC	B7

Order no.		
118	43435	** *

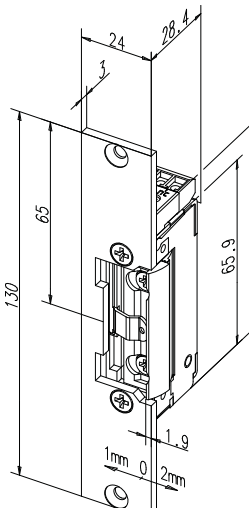

Electric strike 118 with short flat striking plate 096

With 2 fixing holes, for steel doors without dead bolt

Technical attributes	
Colour	35
Type	kl

DIN directions	
Universal	1

Voltage	
10-24 V AC/DC	A7
22-42 V AC/DC	B7

Order no.		
118	09635	** *

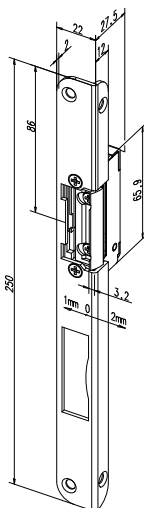

Electric strike 118 with angled striking plate 513

With 4 fixing holes, for rebated wooden doors

Technical attributes	
Colour	35
Type	iW

DIN directions	
Left	4
Right	5

Voltage	
10-24 V AC/DC	A7
22-42 V AC/DC	B7

Order no.		
118	51335	** *

Fail-unlocked 138

118 128 138

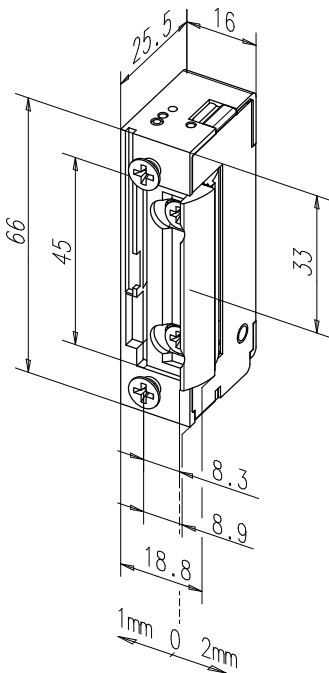

Minimum fitting size - maximum effect
effeff standard electric strike 138 with FaFix (FF)

Model with basic features.

The advantages at a glance

- Radius keeper, FaFix 3 mm adjustable
- Universal voltage
- Compatible with all current mortise locks
- Compatible with all commercially available striking plates also striking plates for plastic profiles
- Symmetrical design. DIN left/right as well as horizontal applicable

Electrical data	12 V DC	24 V DC
Rated resistance	51 Ω	160 Ω
Current consumption DC (stabilised)	235 mA	150 mA
Max. keeper pre-load DC (stabilised)	30 N	30 N

Characteristics	Technical attributes
Adjustable keeper (FF, FaFix)	• Break-in resistance 3750 N
Adjustable strike (F, Fix)	• Height 66 mm
Monitoring contact (RR)	• Width 16 mm
Diode (05)	• Depth 25,5 mm
Fail-unlocked	• Operating temperature range -15 °C to +40 °C
Hold-open function	• Installation position vertical and horizontal
	• Material housing Die-cast zinc
	• Material keeper Die-cast zinc
	• Fafix regulating range 3 mm
	• Latch bolt engaging depth 5,5 mm
	• Internal works continuous function load cycles 250000

DIN directions	
Universal	1
Voltage	
12 V DC	E9
24 V DC	F9

Order no.
138----- ** *

Standard combinations fail-unlocked 138

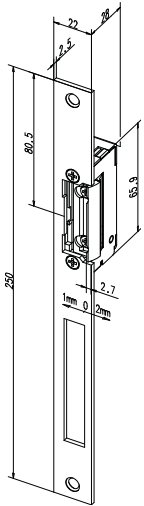

Electric strike 138 with flat striking plate 434

With 2 fixing holes, for steel doors

Technical attributes		DIN directions	
Colour	35	Universal	1
Type	HZ		
		Voltage	
		12 V DC	E9
		24 V DC	F9
Order no.			
138---43435 ** *			

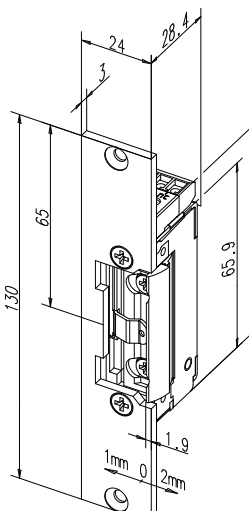

Electric strike 138 with short flat striking plate 096

With 2 fixing holes, for steel doors without dead bolt

Technical attributes		DIN directions	
Colour	35	Universal	1
Type	kl		
		Voltage	
		12 V DC	E9
		24 V DC	F9
Order no.			
138---09635 ** *			

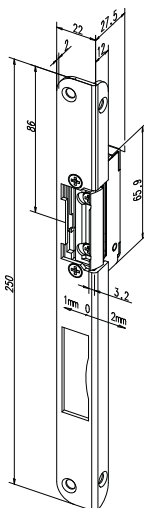

Electric strike 138 with angled striking plate 513

With 4 fixing holes, for rebated wooden doors

Technical attributes		DIN directions	
Colour	35	Left	4
Type	iW	Right	5
		Voltage	
		12 V DC	E9
		24 V DC	F9
Order no.			
138---51335 ** *			

Model series 118, 128 and 138 ProFix 2 at a glance

Standard-electric strike ProFix 2

effeff-standard-electric strike 118 ProFix 2

With its dimensions of 66 mm x 16 mm x 25.5 mm, effeff door strike 118 is the smallest ProFix 2 electric strike in the world.

Model 118 is an all purpose electric strike. Its compact design enables it not only to open up doors, but also new potentials. There is also no need for you to go without standard extras such as a feedback signal contact, a hold-open function, an actuating lever and a diode. Both fail secure and fail safe modes of operation are available. The voltage range makes it easy for you to choose the voltage, thus also reducing warehousing space. The optional plug-in connection cable means connecting up is child's play and fitting thus takes even less time.

The advantages at a glance:

- Universal voltage
- Pluggable connecting cable available
- Symmetrical design. DIN left/right as well as horizontal applicable
- Optimum sliding ramp for a soft interplay with latch bolt
- Compatible to current ProFix 2 striking plates
- Usable from a x-dimension to 4 mm

What is ProFix?

Please see chapter „Technical Explanations“

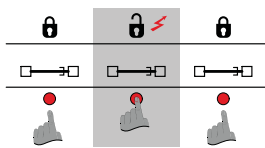

Fail locked function

The door can only be opened while a contact is made. In alternating current operation, a humming noise is audible. In direct current operation, there is no noise.

Adjustable keeper (FF, FaFix)	Monitoring contact (RR)	Mechanical unloking (E)	Diode (05)	Fail-locked	Model
•				•	118.13
•		•		•	118E.13
•	•			•	118.23
•	•	•		•	118E.23
•			•	•	118.53
•		•	•	•	118E.53
•	•		•	•	118.63

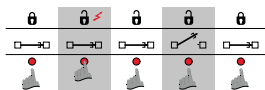

Hold-open function

The latch bolt-controlled hold-open catch in the centre of the keeper holds the strike unlocked even after a contact is made until the door is opened.

Adjustable keeper (FF, FaFix)	Mechanical unloking (E)	Hold-open function	Model
•		•	128.13
•	•	•	128E.13

Model series 118, 128 and 138 ProFix 2 at a glance

Standard-electric strike ProFix 2

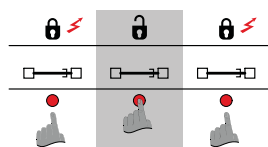

Fail-unlocked function
 The strike is blocked as long as the power is switched on. Once the current is switched off or interrupted due to a power failure, the keeper can be moved and the door opened.

Adjustable keeper (FF, FaFix)	Monitoring contact (RR)	Diode (05)	Fail-unlocked	Model
•			•	138.13
•	•		•	138.23
•		•	•	138.53
•	•	•	•	138.63

Fail-locked 118.13/128.13

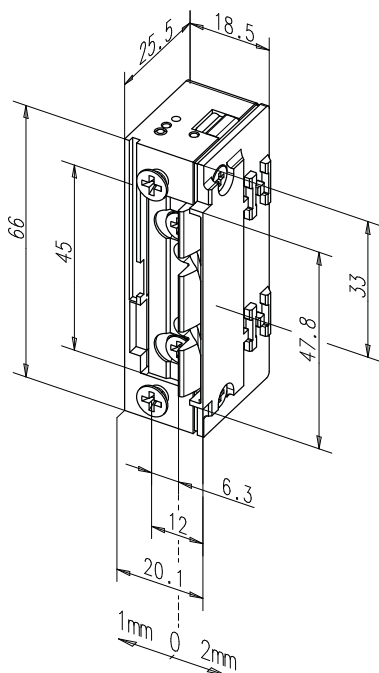
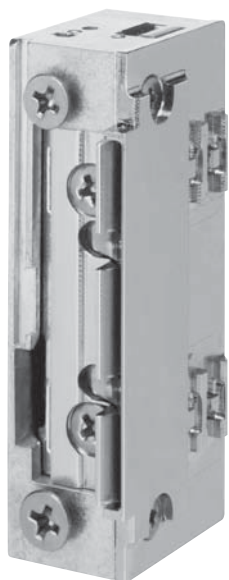

Minimum fitting size - maximum effect effeff-standard-electric strike 118 ProFix 2 with FaFix (FF)

Model with basic features.

The advantages at a glance

- Compatible with all current mortise locks
- Symmetrical design. DIN left/right as well as horizontal applicable
- Optimum sliding ramp for a soft interplay with latch bolt
- Compatible to current ProFix 2 striking plates
- Usable from a x-dimension to 4 mm
- 3 mm adjustable keeper (FaFix)

Electrical data	10-24 V AC/DC	22-42 V AC/DC
Rated resistance	43 Ω	200 Ω
AC current consumption	250 mA (12V) 500 mA (24V)	60 mA
Current consumption DC (stabilised)	280 mA (12V) 560 mA (24V)	120 mA
Max. keeper pre-load AC	200 N (12V) 250 N (24V)	200 N
Max. keeper pre-load DC (stabilised)	50 N (12V) 200 N (24V)	50 N

Characteristics	Technical attributes
Adjustable keeper (FF, FaFix)	• Break-in resistance 3750 N
Adjustable strike (F, Fix)	Height 66 mm
Monitoring contact (RR)	Width 20,1 mm
Mechanical unlocking (E)	Depth 25,5 mm
Diode (05)	Operating temperature range -15 °C to +40 °C
Fail-locked	• Installation position vertical and horizontal
Hold-open function	Fafix regulating range 3 mm
	Latch bolt engaging depth 5,5 mm
	Internal works continuous function load cycles 250000

DIN directions	
Universal	1
Voltage	
10-24 V AC/DC	A7
22-42 V AC/DC	B7
Order no.	
118.13 -----	** *

Order suffix for model with hold open function = 128.13 -...

Standard combinations fail-locked 118.13/128.13

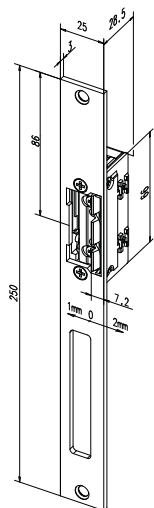

Electric strike 118.13 with flat striking plate 55A

With 2 fixing holes, for PVC and aluminium doors

Technical attributes	
Colour	35
Type	HZ

DIN directions	
Universal	1

Voltage	
10-24 V AC/DC	A7
22-42 V AC/DC	B7

Order no.		
118.13-55A35	**	*

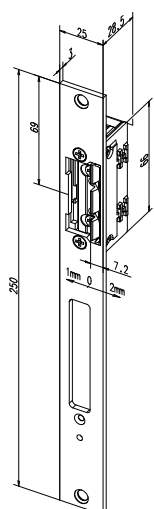

Electric strike 118.13 with flat striking plate 712 pre-equipped for bolt switching contact model 878

With 2 fixing holes, for PVC and aluminium doors

Technical attributes	
Colour	35
Type	HZ

DIN directions	
Universal	1

Voltage	
10-24 V AC/DC	A7
22-42 V AC/DC	B7

Order no.		
118.13-71235	**	*

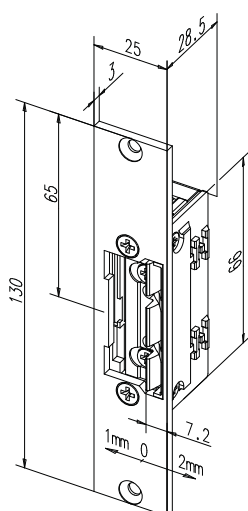

Electric strike 118.13 with short flat striking plate 688

With 2 fixing holes, for PVC and aluminium doors without dead bolt

Technical attributes	
Colour	35
Type	kF

DIN directions	
Universal	1

Voltage	
10-24 V AC/DC	A7
22-42 V AC/DC	B7

Order no.		
118.13-68835	**	*

Standard combinations fail-locked 118.13/128.13

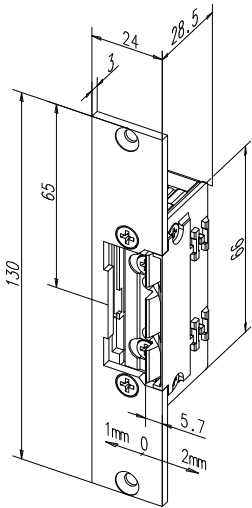

Electric strike 118.13 with short flat striking plate 689

With 2 fixing holes, for steel doors without dead bolt

Technical attributes		DIN directions	
Colour	35	Universal	1
Type	kl		
		Voltage	
		10-24 V AC/DC	A7
		22-42 V AC/DC	B7
		Order no.	
		118.13-68935	** *

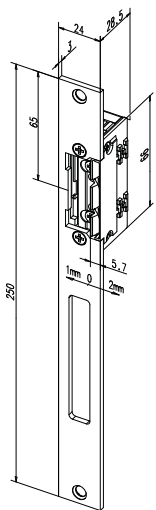

Electric strike 118.13 with flat striking plate 690

With 2 fixing holes, for steel doors

Technical attributes		DIN directions	
Colour	35	Universal	1
Type	HZ		
		Voltage	
		10-24 V AC/DC	A7
		22-42 V AC/DC	B7
		Order no.	
		118.13-69035	** *

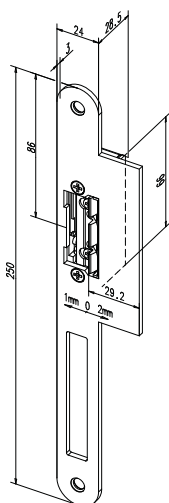

Electric strike 118.13 with flanged striking plate

With 2 fixing holes, for flush wooden doors

Technical attributes		DIN directions	
Colour	35	Universal	1
Type	Lap		
		Voltage	
		10-24 V AC/DC	A7
		22-42 V AC/DC	B7
		Order no.	
		118.13-52A35	** *

Standard combinations fail-locked 118.13/128.13

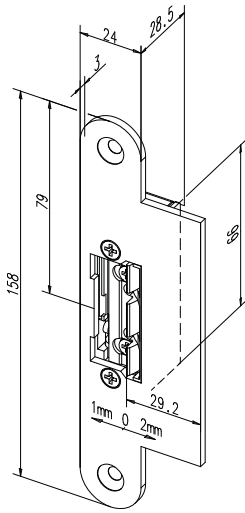

Electric strike 118.13 with short flanged striking plate 53A

With 2 fixing holes, for flush wooden doors without dead bolt

Technical attributes		DIN directions	
Colour	35	Universal	1
Type	kl		
Voltage			
		10-24 V AC/DC	A7
		22-42 V AC/DC	B7
Order no.			
		118.13-53A35	** *

Fail-unlocked 138.13

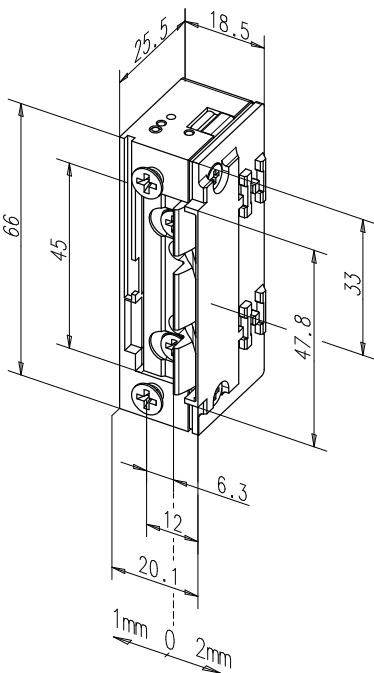
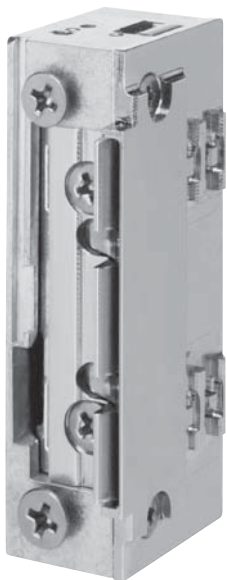

Minimum fitting size - maximum effect
effe standard electric strike 138 ProFix 2 with FaFix (FF)

Model with basic features.

The advantages at a glance

- Compatible with all current mortise locks
- Symmetrical design. DIN left/right as well as horizontal applicable
- Optimum sliding ramp for a soft interplay with latch bolt
- Compatible to current ProFix 2 striking plates
- Usable from a x-dimension to 4 mm
- 3 mm adjustable keeper (FaFix)

Electrical data	12 V DC	24 V DC
Rated resistance	51 Ω	160 Ω
Current consumption DC (stabilised)	235 mA	150 mA
Max. keeper pre-load DC (stabilised)	30 N	30 N

Characteristics	Technical attributes
Adjustable keeper (FF, FaFix)	• Break-in resistance 3750 N
Adjustable strike (F, Fix)	• Height 66 mm
Monitoring contact (RR)	• Width 20,1 mm
Diode (05)	• Depth 25,5 mm
Fail-unlocked	• Operating temperature range -15 °C to +40 °C
Hold-open function	• Installation position vertical and horizontal
	• Fafix regulating range 3 mm
	• Latch bolt engaging depth 5,5 mm
	• Continuous function load cycles 250000

DIN directions	Order no.
Universal	1
Voltage	
12 V DC	E9
24 V DC	F9
	↓ ↓
	138.13----- ** *

116 126 136 ProFix2

Standard combinations fail-unlocked 138.13

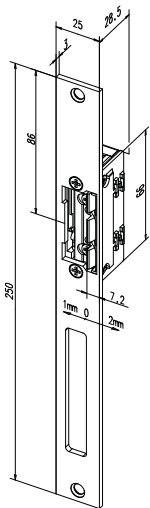

Electric strike 138.13 with flat striking plate 55A

With 2 fixing holes, for PVC and aluminium doors

Technical attributes		DIN directions	
Colour	35	Universal	1
Type	HZ		
		Voltage	
		10-24 V AC/DC	A7
		22-42 V AC/DC	B7
Order no.			
138.13-55A35 ** *			

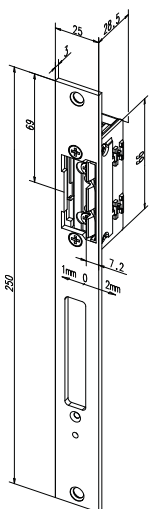

Electric strike 138.13 with flat striking plate 712 pre-equipped for bolt switching contact model 878

With 2 fixing holes, for PVC and aluminium doors

Technical attributes		DIN directions	
Colour	35	Universal	1
Type	HZ		
		Voltage	
		12 V DC	E9
		24 V DC	F9
Order no.			
138.13-71235 ** *			

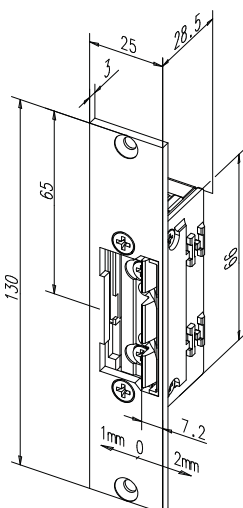

Electric strike 138.13 with short flat striking plate 688

With 2 fixing holes, for PVC and aluminium doors without dead bolt

Technical attributes		DIN directions	
Colour	35	Universal	1
Type	kF		
		Voltage	
		12 V DC	E9
		24 V DC	F9
Order no.			
138.13-68835 ** *			

Standard combinations fail-unlocked 138.13

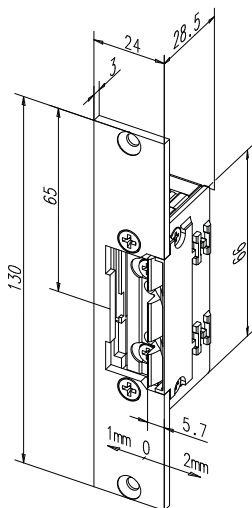

Electric strike 138.13 with short flat striking plate 689

With 2 fixing holes, for steel doors without dead bolt

Technical attributes	
Colour	35
Type	kl

DIN directions	
Universal	1

Voltage	
12 V DC	E9
24 V DC	F9

Order no.		
138.13-68935	**	*

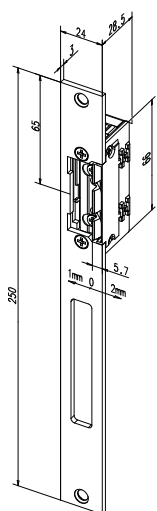

Electric strike 138.13 with flat striking plate 690

With 2 fixing holes, for steel doors

Technical attributes	
Colour	35
Type	HZ

DIN directions	
Universal	1

Voltage	
12 V DC	E9
24 V DC	F9

Order no.		
138.13-69035	**	*

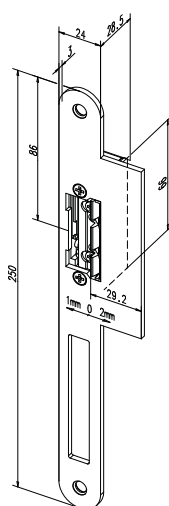

Electric strike 138.13 with flanged striking plate 52A

With 2 fixing holes, for flush wooden doors

Technical attributes	
Colour	35
Type	Lap

DIN directions	
Universal	1

Voltage	
10-24 V AC/DC	A7
22-42 V AC/DC	B7

Order no.		
138.13-52A35	**	*

Standard combinations fail-unlocked 138.13

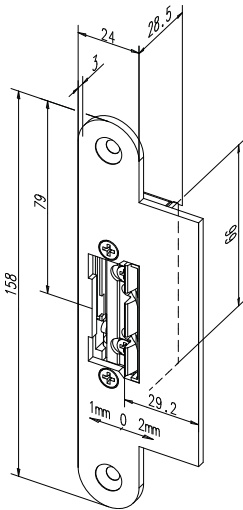

Electric strike 138.13 with short flanged striking plate 53A

With 2 fixing holes, for flush wooden doors without dead bolt

Technical attributes		DIN directions	
Colour	35	Universal	1
Type	kl		
Voltage			
10-24 V AC/DC	A7		
22-42 V AC/DC	B7		
Order no.			
138.13-53A35		**	*



Nolimal d.o.o.
Cesta pod goro 42, 1353 Borovnica, Slovenija
tel.: 01/754 83 60, fax: 01/754 83 61,
www.nolimal.si; info@nolimal.si